

ibidi Application Guide

Live Cell Imaging

Investigate Biological Processes in Real Time 2

Physiological Conditions Under the Microscope . . 3

Parameters for Live Cell Imaging 3

Temperature 4

Carbon Dioxide (CO₂) Levels and pH of the Medium . 4

Condensation 4

Humidity and Evaporation 5

Oxygen (O₂) Levels 6

Imaging Method and Photon Dose 6

The Live Cell Imaging Experiment 7

Requirements at a Glance 7

Stage Top Incubator 8

Fluorescence Staining 8

Microscope 9

Image Acquisition 10

Experimental Examples 11

Restructuring of the Human Macrophage Cytoskeleton During Borreliae Uptake 11

Live Imaging of Gap Closure in a Wound Healing Assay 11

Live Microscopy of Endothelial Cell Tube Formation. 12

Live Visualization of Cell Migration During a Chemotaxis Assay 12

Visualization of the Contraction of Cardiomyocytes . 12

Live Cell Imaging of Actin Dynamics in a Chemotactic Gradient. 13

Imaging of Actin Dynamics Under Flow. 13

Selected Publications

B. Kleinedam, S. Sielker, M. Hanisch, et al. The micromass formation potential of human adipose-derived stromal cells isolated from different various origins. *Head & Face Medicine*, 2018, 10.1186/s13005-018-0178-0.

[read abstract](#)

W. Eldridge, J. Hoballah and A. Wax. Molecular and biophysical analysis of apoptosis using a combined QPI and FRET microscope. *Journal of Biophotonics*, 2018, 10.1002/jbio.201800126.

[read abstract](#)

M. Salker, N. Schierbaum, N. Alowayed, et al. LeftyA decreases Actin Polymerization and Stiffness in Human Endometrial Cancer Cells. *Scientific Reports*, 2016, 10.1038/srep29370.

[read abstract](#)

G. Davey, Z. Adhireksan, Z. Ma, et al. Nucleosome acidic patch-targeting binuclear ruthenium compounds induce aberrant chromatin condensation. *Nature Communications*, 2017, 10.1038/s41467-017-01680-4.

[read abstract](#)

E. Alves Barbosa, A. Oliveira, A. Plácido, et al. Structure and function of a novel antioxidant peptide from the skin of tropical frogs. *Free Radical Biology and Medicine*, 2017, 10.1016/j.freeradbiomed.2017.11.001.

[read abstract](#)

Investigate Biological Processes in Real Time

Live cell imaging is the time-lapse microscopy of dynamic processes in living cells. It enables observation of cell-cell interactions, the behavior of single cells, and the dynamics of cell organelles or cellular molecules. Several imaging techniques can be applied, such as phase contrast microscopy, fluorescence and confocal microscopy, multiphoton microscopy, light sheet microscopy, or even TIRF and super-resolution microscopy.

Many topics in cell biology can be addressed using live cell imaging:

- Investigating cell migration in chemotaxis assays or wound healing assays, for example
- Mimicking blood or lymphatic vessels using cell culture under flow
- Studying angiogenesis with tube formation assays
- Measuring cell proliferation over time
- Analyzing inter- and intracellular signaling using specific fluorescence staining and high-resolution microscopy
- Gaining insight into the cytoskeletal dynamics

During the whole live cell imaging experiment, the cells need to be kept alive and healthy. Therefore, physiological conditions have to be established and maintained on the microscope. For both the researcher and the equipment, this presents several challenges and requires exact experimental planning. However, live cell microscopy offers many novel possibilities for achieving a better understanding of the biological dynamics within the cell.

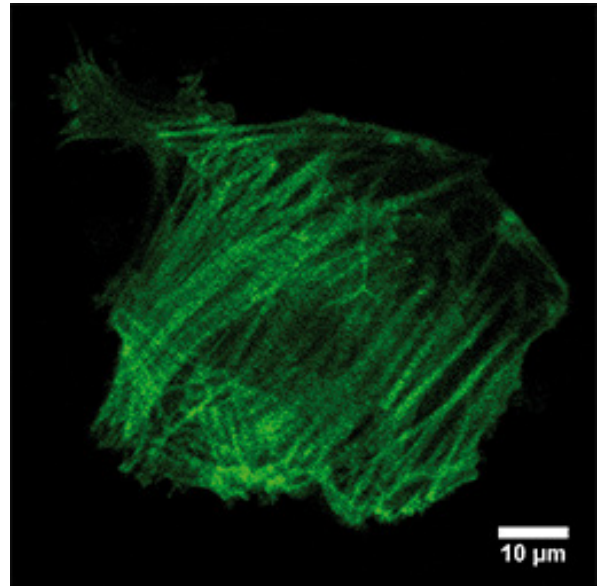

High-resolution live cell imaging for the visualization of the contraction rates of cardiomyocytes, plated in a [μ-Dish^{35 mm, high}](#) [ibiTreat](#) (coated with Fibronectin). F-Actin is stained with [mRFLifeAct-TagGFP2](#). 100x objective lens.

[Click here](#) to watch the movie on our website.

Physiological Conditions Under the Microscope

Cells react sensitively to changes in their environment. Factors such as temperature, humidity, and CO_2/O_2 levels significantly influence the outcome of cell culture assays. In order to achieve biologically relevant and reproducible results, it is crucial to maintain optimal conditions on the microscope stage during live cell imaging experiments.

To enable high-quality live cell imaging under physiological conditions, the following parameters need to be considered:

Environment:

- [Temperature](#)
- [Carbon Dioxide \(\$\text{CO}_2\$ \) Levels and pH of the Medium](#)
- [Humidity and Evaporation](#)
- [Oxygen \(\$\text{O}_2\$ \) Levels](#)

Optical Aspects:

- [Condensation](#)
- [Imaging Method and Photon Dose](#)

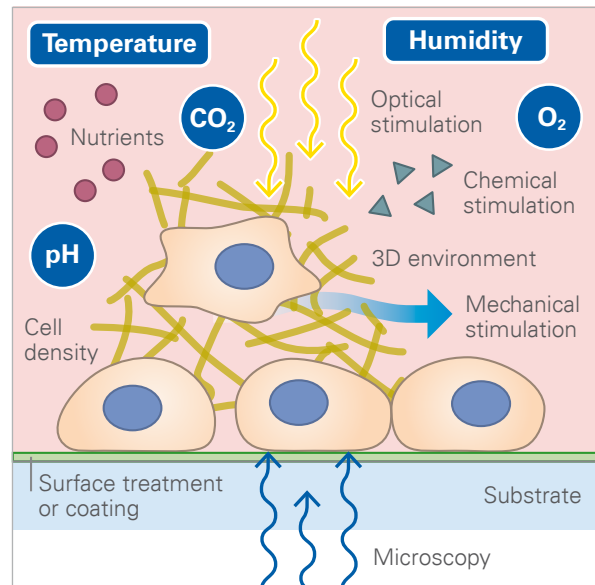

ibidi Solution

The [ibidi Stage Top Incubation Systems](#) are available for slides/dishes and for multiwell plates. They allow for accurate and reliable control of important live cell imaging parameters (temperature, CO_2 and O_2 concentration, and relative humidity) during short-term and long-term assays on any inverted microscope. If additional control of the oxygen level is needed (e.g., in hypoxia experiments), the ibidi Stage Top Incubation Systems, CO_2/O_2 are the ideal solution.

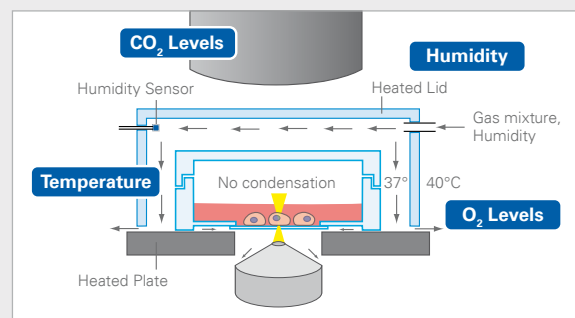

Temperature

The environmental temperature strongly influences the metabolism and the activity of cells. Temperature changes affect cell adhesion, protein expression, proliferation, and many more cellular parameters.

Generally, 37°C (which is our normal body temperature) is optimal for mammalian cell culture, including human, mouse, and rat cells. Cells from non-mammalian organisms, such as chick or yeast, require different temperatures.

In order to get robust and reliable results, and to maintain focus stability, the temperature of the cells and their direct environment must be kept as constant as possible during both short-term and long-term live cell imaging experiments.

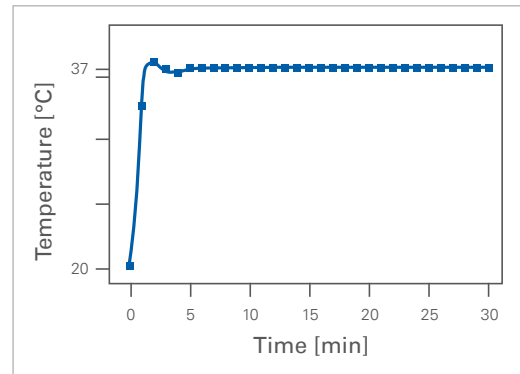

Temperature development over time after switching on the ibidi Stage Top Incubator. The set temperature is reached quickly and remains stable over time.

Carbon Dioxide (CO₂) Levels and pH of the Medium

A pH of 7.2–7.4 provides optimal growth conditions for most mammalian cells. The ambient carbon dioxide (CO₂) levels are an important parameter for live cell imaging, since they influence the pH of the cell culture medium.

For a stable pH, many cell culture media use the bicarbonate buffer system, which is the main physiological buffer system in our blood. Typically, the medium contains sodium bicarbonate (NaHCO₃), which balances with the carbonic acid (H₂CO₃) and the CO₂ in the air. In a standard 5% CO₂ incubation atmosphere, bicarbonate-buffered cell culture media exhibit a pH of 7.4. However, the required CO₂ level in the ambient air can be different when using a special medium. Please consider the manufacturer's manual for the pH requirements of your applied cell culture medium.

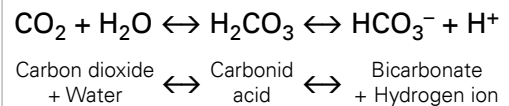

Equation of the bicarbonate-buffered system.

Changes in the atmospheric CO₂ lead to the alteration of pH in the medium. Constant CO₂ levels are therefore crucial for reproducible cell culture assays. Most commercial cell culture media contain phenol red as a color indication for the pH. The medium should be replaced if the color turns yellow (acidic) or purple (alkaline).

Apart from the bicarbonate buffer system, organic chemical buffering using HEPES is possible. In this system, a controlled amount of CO₂ in the ambient air is not required. However, HEPES can be toxic for some cell types.

Condensation

Humidity in ambient air can lead to condensation on all surfaces, especially on the lids of cell culture vessels. If these surfaces are within the optical pathway, small water droplets will cause light scattering. This diminishes the optical quality of transmitted light microscopy (i.e., phase contrast and DIC).

To ensure the highest image quality, condensation on any surface must be prevented during live cell imaging experiments.

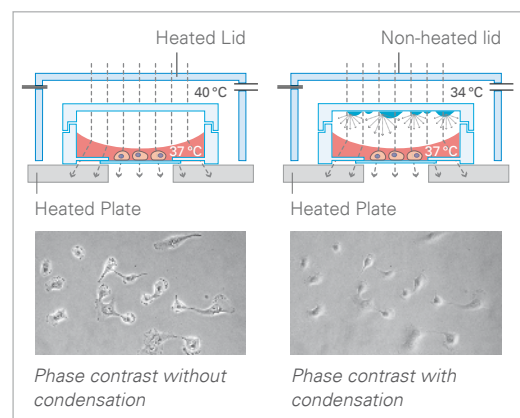

Humidity and Evaporation

Constant levels of salts, nutrients, and other cell culture medium components are essential for reproducible cell behavior. Salt concentrations that are too high can be toxic and lead to cell death. Evaporation from cell culture vessels increases the concentrations of substances in the medium in an undefined way. This happens particularly fast in low-volume cultures. The consequences of evaporation caused by too low humidity are frequently underestimated. Cells even react more sensitively to concentration changes than to temperature changes, which can markedly distort the results. Therefore, evaporation from cell culture vessels during live cell imaging experiments should be absolutely avoided.

Cell culture vessels in the CO₂ incubator are normally cultivated in an open system (e.g., gases can diffuse through the cell culture plastics), and are therefore in an equilibrium with the surrounding air. To minimize evaporation, the relative humidity (RH) within an incubation system should be within the range of 90%–95%. In standard CO₂ incubators, the humidity is created with evaporation from a water tray. During a live cell imaging experiment, the evaporation in the stage top incubator should be kept as low as possible, underlining the need for a reliable humidity control within the stage top incubator.

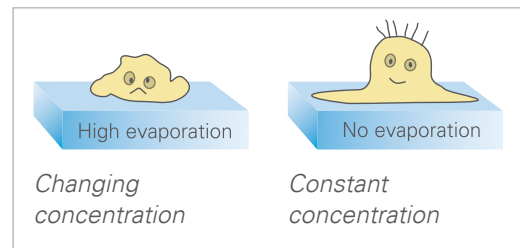

ibidi Solutions

The ibidi Stage Top Incubation Systems...

- ... provide a stable and homogenous **temperature** for live cell imaging experiments. The temperature is smoothly changeable and can easily be adapted to the requirements of the investigated cell type.
- ... provide stable **CO₂ levels** in the cell culture chamber directly on the microscope. The ambient CO₂ level is changeable within a range of 0%–15% and can be easily adapted to the requirements of the cell type and the medium being used.
- ... **prevent from condensation** on the lid of the cell culture vessel through their independently controlled heated glass lid and active humidity control. By heating the lid to a temperature higher than the plate, a vertical temperature gradient is created.
- ... provide a patented and best-in-class, feedback-controlled **humidity regulation**. The humidity in this system is constant and can be smoothly adapted to specific experimental needs. With a possible humidity of up to nearly 100%, the evaporation within the system is securely prevented.

The ibidi Channel Slides...

- ... prevent from condensation inside the optical pathway by making it intrinsically impossible.

The ibidi μ -Dishes...

- ... are optimized for low evaporation. Their lids can be set to a lock position, ensuring minimal evaporation.

The ibidi Anti-Evaporation Oil...

- ... helps to reduce evaporation in long-term studies. This silicone oil is overlaid onto the medium, thus decreasing evaporation. Silicone oil is highly gas permeable for O₂ and CO₂, but effectively blocks humidity loss. Find out more in the Application Note [AN 12: Avoiding Evaporation \(PDF\)](#).

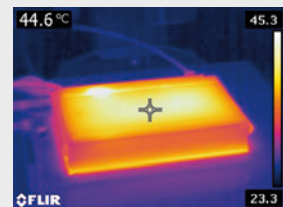

Oxygen (O₂) Levels

The oxygen (O₂) concentration at normal atmospheric pressure is around 20–21%. However, the O₂ levels in healthy body tissues, and in our blood, are much lower. Variations in the oxygen concentration are part of the normal body system, with ranges from 14% in the alveoli to 5% in peripheral tissues.

The oxygen levels can be even lower in pathological situations (hypoxia). This especially occurs in tumor tissue, which is characterized by markedly low O₂ levels that range from approximately 4% to a minimum of below 0.5%.

In live cell imaging assays, the O₂ concentration is another important parameter that needs to be controlled, particularly when working with tumor cells or when analyzing the effects of hypoxia.

McKeown SR (2014) Defining normoxia, physoxia and hypoxia in tumours-implications for treatment response. *Br J Radiol* 87(1035):20130676. 10.1259/bjr.20130676.

[read abstract](#)

O₂ Partial Pressure in Tissue
(1 kPa \approx 1 % in gas mix \approx 7.5 mm Hg)

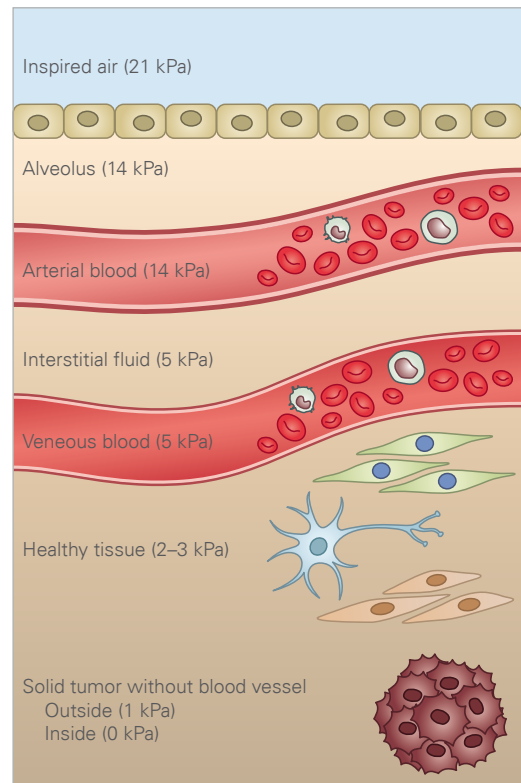

ibidi Solution

For hypoxia assays, the [CO₂/O₂ versions of the ibidi Stage Top Incubation Systems](#) allow for the precise control of the oxygen levels in your cell culture vessel. The ambient O₂ level can be controlled within a range of 1%–21%, and can be easily adapted to the experimental requirements.

To make accurate O₂ measurements, we recommend using one of the systems from [ColibriPhotonics](#) and [preSens GmbH](#).



Imaging Method and Photon Dose

Since many cellular processes can be visualized directly on the microscope, different imaging techniques are required.

Some of these experiments, such as rolling adhesion, chemotaxis, or tube formation assays, do not require any staining and can be easily imaged using bright-field (e.g., phase contrast microscopy). Even though bright-field illumination has only a little phototoxicity, it should still be minimized. For example, the light should only be switched on during image acquisition. Additionally, the necessary light intensity can be minimized by using sensitive cameras.

However, fluorescence microscopy that uses reporter proteins like GFP will reveal more structural details and molecular interaction. When using fluorescence-based microscopy techniques (e.g., confocal microscopy), it is especially crucial to minimize the cell stress that is caused by excitation light. Phototoxic effects and photobleaching happen quickly in living cells and might alter the outcome of the experiment.

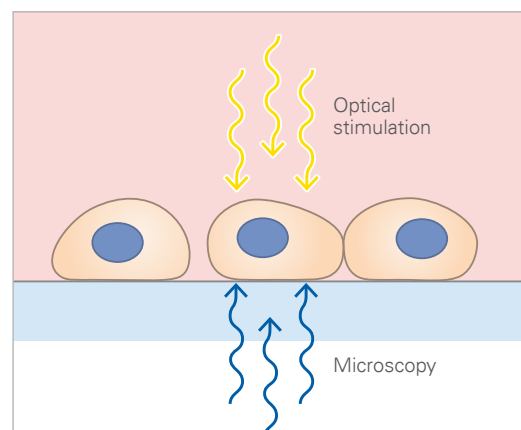

Find more details about the different live cell [microscopy requirements and techniques](#), [fluorescence staining techniques](#) and how to [prevent photobleaching](#).

The Live Cell Imaging Experiment

Requirements at a Glance

Environment

- Stable conditions (e.g., temperature, humidity, light, and vibrations)

Stage Top Incubator

- Precise and stable control of physiological parameters:
- Temperature, humidity, CO₂ levels, O₂ levels (optional)
- Compatible with:
 - Microscope (microscope table, objective)
 - Cell culture vessels being used

Fluorescence Staining

- Non-invasive
- Specific
- Highly photostable
- Requires low photon dose (less phototoxicity) for detectability

Microscope

- Inverted microscope; configuration depends on experimental setup
- Camera for time-lapse image acquisition
- Motorized stage for parallel image acquisition
- Autofocus (hardware- or software-based)
- Secured against vibrations

Image Acquisition

- High signal-to-noise ratio
- Low photon dose
- Adequate resolution (depends on experimental setup)

Computer and Data Storage

- Hardware suitable for quick storage of huge amounts of data
- Software for data analysis

ibidi Solutions

Physiological parameters:

The [ibidi Stage Top Incubation Systems](#) guarantee fast and precise control of temperature, humidity, CO₂ levels, and O₂ levels (optionally) of living samples, thereby creating and maintaining stable conditions for cell culture directly on the microscope.

Compatibility with microscopes:

The [ibidi Stage Top Incubation Systems](#) can be easily applied to all standard microscope stages that hold a multiwell holder, a K-frame stage, or a Nikon Eclipse Ti and Eclipse Ti2 motorized stage, respectively. Notably, the ibidi Stage Top Incubation Systems are mounted quickly on the microscope, just like a multiwell plate. They can also be easily removed after the experiment, enabling access for standard microscope applications that do not require live cell imaging.

Please find more compatibility information [in the FAQ section of our website](#) or [contact our expert team](#).

Compatibility with cell culture vessels:

The [ibidi Stage Top Incubation Systems](#) can be used with different cell culture vessels, including [dishes](#), [slides](#), and [microplates](#).

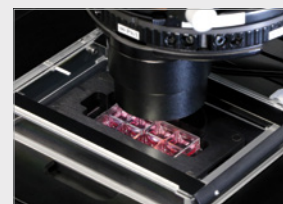

Stage Top Incubator

The most important factor for live cell imaging is the maintenance of cell viability, meaning that incubator conditions have to be established and maintained on the microscope. A stage top incubator must provide a precise and stable control of the temperature, humidity, CO₂ levels, and, optionally, O₂ levels. Keeping these parameters constantly in a physiological state ensures optimal experimental conditions and produces reliable, reproducible results.

Compatibility with the microscope being used, especially to the microscope stage and the objective setup, is crucial for a stage top incubator. Furthermore, the stage top incubator must be compatible with the cell culture vessels being utilized in the respective experiment. Ideally, many different vessels can be used in the same stage top incubator.

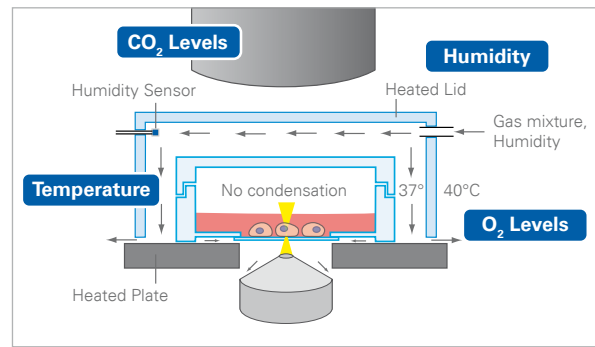

With fast and precise regulation of important environmental parameters, the ibidi Stage Top Incubators provide stable conditions for live cell imaging directly on the microscope.

Fluorescence Staining

Light microscopy without any staining is sufficient for several live cell imaging approaches, such as wound healing assays, chemotaxis assays, or tube formation assays. However, the analysis of single cellular structures requires a more specific approach like fluorescence microscopy.

Importantly, a fluorescence dye for live cell imaging applications needs to be specific and non-invasive. In addition, the fluorochrome must have a high photostability, since the imaging process may take several hours. Finally, cells are damaged by being exposed to photons. To reduce phototoxicity, fluorochrome detection requires the least possible photon dose, which also depends on the fluorophore and the applied microscopy technique. ibidi recommends performing a sufficient number of control experiments to exclude artefacts from phototoxicity, fluorescence stainings, and protein-tagged reporters.

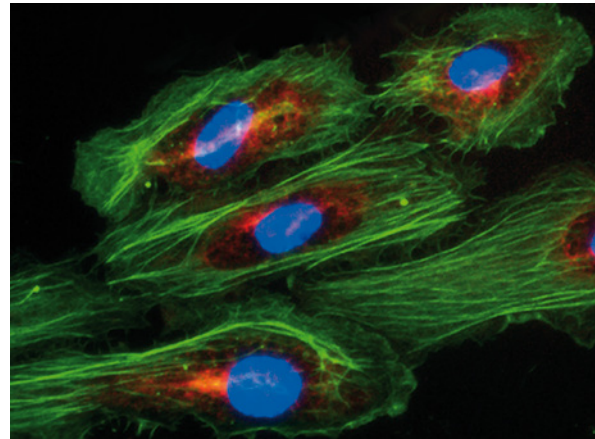

*Triple immunofluorescence of HUVEC cells.
Red: mitochondria, stained with MitoTracker™ Red CMXRos;
Green: F-actin, stained with Alexa Fluor™ 488 Phalloidin;
Blue: nuclei, stained with DAPI.*

Find more details about how to prevent phototoxicity [here](#).

Find more details about fluorescence staining techniques and immunofluorescence [on our website](#).

Microscope

General Microscope Requirements

The optimal microscope type and configuration depend on the experiment being performed. However, some requirements apply to all microscopes being used for live cell imaging assays.

Live cell imaging microscopes are usually **inverted**, because most cell types sink to the bottom and onto the coverslip for adherence. In an inverted microscope, living cells are observed through the bottom of a cell culture vessel. Find the advantages of using an inverted microscope for live cell imaging [on our website](#).

Using a **camera** for time-lapse image acquisition is necessary with every live cell experiment. In the case of fluorescence imaging, a sensitive camera should be used to take images with a high signal-to-noise ratio and a high acquisition speed.

If the sequential acquisition of images at multiple positions is needed, the microscope should be equipped with a **motorized stage**.

When using high-resolution time-lapse microscopy, we recommend the application of an **autofocus** system. This may be a hardware-based optical focus drift correction system like the Nikon Perfect Focus System (PFS), or a software-based autofocus.

The microscope should be **protected against vibrations** by using, for example, a special anti-vibration microscope table.

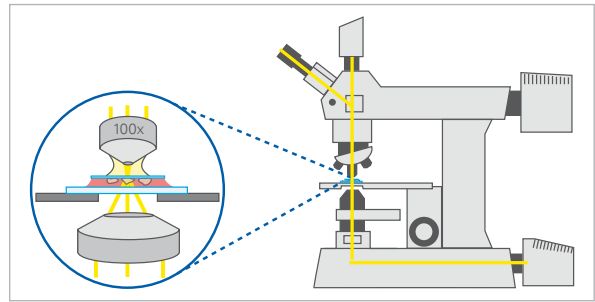

Microscopy Techniques

Depending on the research topic and availability of equipment, many microscopy techniques are suitable for live cell imaging.

Light microscopy is sufficient for several live cell imaging approaches, such as [wound healing assays](#), [chemotaxis assays](#), or [tube formation assays](#). In this instance, [phase contrast microscopy](#) or [differential interference contrast \(DIC\) microscopy](#) can be used, because neither require any staining.

Fluorescence microscopy is widely used when a more specialized analysis is needed. This can be the observation of a special cell organelle, a single protein, or the dynamics of the cytoskeleton, for example. Since fluorescence microscopy requires photon exposure that damages the cells, the method used is always a compromise between keeping the cells healthy and achieving the highest possible image quality.

For high speed live cell imaging of fluorescent samples, spinning disc confocal microscopy is a useful technique. With very low photobleaching rates, [two-photon and multiphoton microscopy](#) is especially suitable for the live cell imaging of tissue samples with a maximal penetration depth of about 1 mm. For the 3D imaging of thick biological samples as a whole at high time resolution, [light sheet fluorescence microscopy](#) can be applied. Several high magnification microscopy techniques, such as [TIRF](#) and [super-resolution microscopy](#), focus on single molecules.

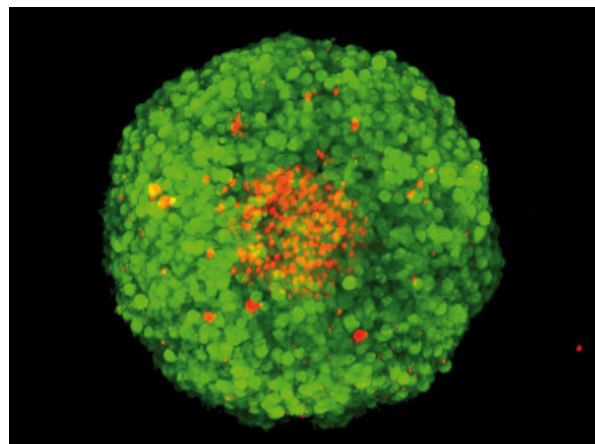

Z-stack of an FDA/PI-stained MCF-7 spheroid, acquisition by confocal microscopy. Green: FDA-stained living cells. Red: PI-stained dead cells in the necrotic center of the spheroid.

Image Acquisition

Prevention of Phototoxicity

Photo-induced radicals, such as reactive oxygen species (ROS), are the main cause of phototoxicity during live cell imaging. When using fluorescence-based microscopy techniques, it is especially crucial to minimize cell stress caused by excitation light. Phototoxic effects and photobleaching happen quickly in living cells and might alter the outcome of the experiment.

When considering the parameters listed below, it is necessary to find a compromise between an optimal signal-to-noise ratio and a high cell viability. ibidi recommends performing a sufficient number of control experiments to exclude artefacts from phototoxicity.

Here are some recommendations for achieving high cell viability with a good signal-to-noise ratio:

- Use shutters to minimize the time the cells are exposed to excitation.
- Minimize the exposure time per image.
- Maximize the time between the images for cell recovery.
- Close the field diaphragm as far as possible to minimize the area in which the cells are exposed to excitation light.
- Minimize the intensity of the excitation light.
- Use a highly sensitive microscope camera to optimize the signal-to-noise ratio.
- Use only the necessary level of signal-to-noise (e.g., do not always use the maximum signal-to-noise setting).
- Match fluorescence filters and fluorophores as closely as possible.
- Use longer wavelengths (e.g., green or red) instead of UV or blue light excitation for fewer phototoxic effects.
- Use objective lenses with the highest numerical apertures available for optimal signal detection.
- Decrease the background fluorescence by using cell culture vessels with low autofluorescence.
- Add antioxidants, such as vitamin C, to the cell culture medium.

*Icha J, Weber M, Waters JC, Norden C (2017) Phototoxicity in live fluorescence microscopy, and how to avoid it. BioEssays 39(8):1700003. 10.1002/bies.201700003.
[read abstract](#)*

Magnification and Resolution

The magnification of the optical system defines both the resolution and the amount of cellular details that can be visualized.

Choosing the right magnification is a compromise between either having a higher resolution or observing more cells and creating detailed statistics.

Using low-resolution microscopy with a 4x or 10x objective can be advantageous for wound healing, chemotaxis, and tube formation assays, because focusing is less delicate. On the other hand, a high magnification is useful for imaging subcellular details for live cell imaging immunofluorescence assays.

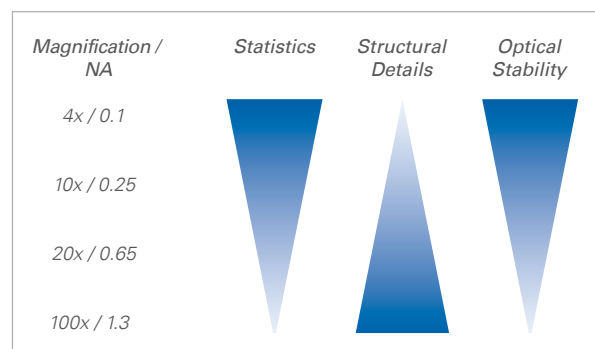

Restructuring of the Human Macrophage Cytoskeleton During Borreliae Uptake

Borrelia bacteria are the cause of the Lyme disease, also known as Lyme borreliosis. To prevent the dissemination of borreliae, their uptake and elimination by macrophages has been shown to be necessary. This process involves dynamic restructuring of the macrophage cytoskeleton, particularly of the actin microfilaments.

In this experiment, the [LifeAct Plasmid](#) was used to visualize actin cytoskeleton reorganization in human macrophages during phagocytosis of borreliae.

Phagocytosis of borreliae by a primary human macrophage. Time-lapse movie of a confocal z-stack showing a primary human macrophage expressing RFP-LifeAct (red) internalizing several GFP-expressing spirochetes (green) with actin-rich cell protrusions. Sequence 41 min. Data by Dr. Mirko Himmel and Prof. Stefan Linder, PhD, Universitätsklinikum Hamburg-Eppendorf, Germany, <http://www.linderlab.de/>.

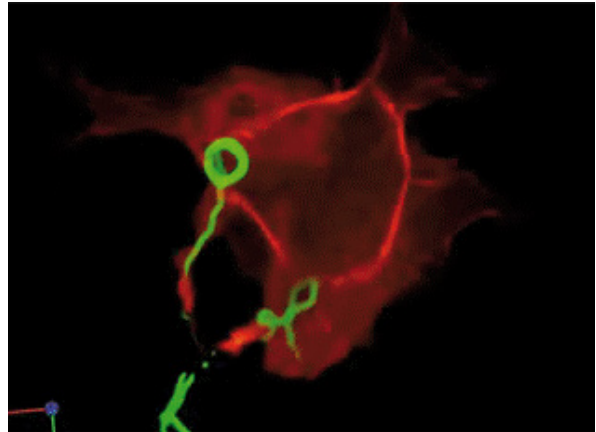

Live Imaging of Gap Closure in a Wound Healing Assay

The [wound healing and migration assay](#) is a widely-used tool for studying cell migration. In the in vitro analysis of wound closure in an MCF7 cell layer, a gap was created by using the [Culture-Insert 2 Well in a \$\mu\$ -Dish^{35 mm, high}](#). The [ibidi Stage Top Incubation System](#) was applied to create and maintain physiologic conditions. To create a time-lapse video of the wound closure, a phase contrast microscopy picture was taken every hour for a total of 29 hours.

Live cell imaging using the ibidi Stage Top Incubation System shows the gap closure of MCF7 cells in a wound healing and migration assay. Phase contrast; 10x objective lens.

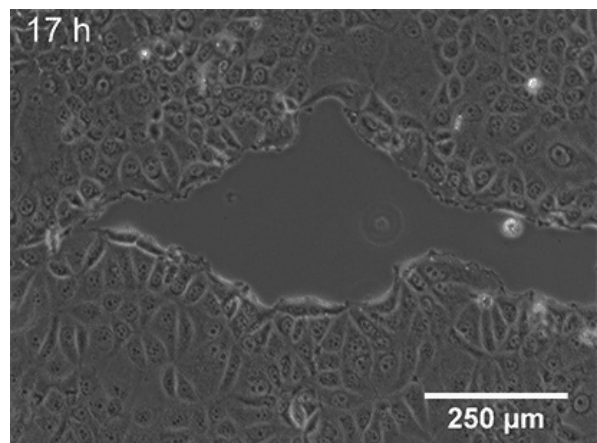

Watch the Movies

Watch these movies and find more live cell imaging examples [on our website](#).

Live Microscopy of Endothelial Cell Tube Formation

The [tube formation assay](#) is a quick and easy-to-perform experiment for analyzing angiogenesis *in vitro*. In the following example using the [μ-Slide Angiogenesis](#), endothelial cells (HUVEC) were seeded on a Matrigel® layer. Physiologic conditions were established and maintained with the [ibidi Stage Top Incubation System](#). To create a time-lapse video of the tube formation, a low-resolution phase contrast microscopy picture was taken every 10 minutes for a total of 24 hours.

Live cell imaging using the ibidi Stage Top Incubation System shows the tube formation of HUVECs in an angiogenesis assay. Phase contrast; 4x objective lens.

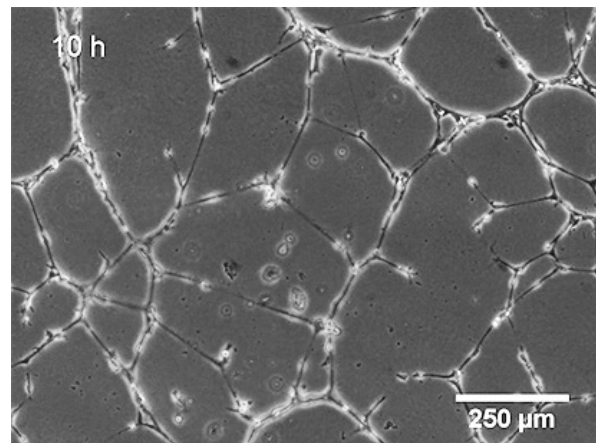

Live Visualization of Cell Migration During a Chemotaxis Assay

A [chemotaxis assay](#) is conducted to analyze whether or not a cell type directly orients and migrates towards a defined chemoattractant. Here, the [μ-Slide Chemotaxis](#) and the [ibidi Stage Top Incubation System](#) were applied in order to monitor directed cell migration under physiologic conditions. Within a time period of 24 hours, 145 pictures were taken in 10 minute intervals. These images serve as raw data for subsequent cell tracking.

Live cell imaging using the ibidi Stage Top Incubation System shows migration of MDA-MB-231 cells in a chemotaxis assay. Phase contrast in a μ-Slide Chemotaxis; 4x objective lens.



Visualization of the Contraction of Cardiomyocytes

For the visualization of the contraction rates of cardiomyocytes, the actin cytoskeleton of iPSC-derived cardiomyocytes was stained using [mRNA LifeAct-TagGFP2](#). Sixteen hours after the transfer, the contractions per minute were measured. The myocytes showed contraction rates of about 70 beats per minute.

High-resolution live cell imaging for the visualization of the contraction rates of cardiomyocytes using mRNA LifeAct-TagGFP2. 100x objective lens.

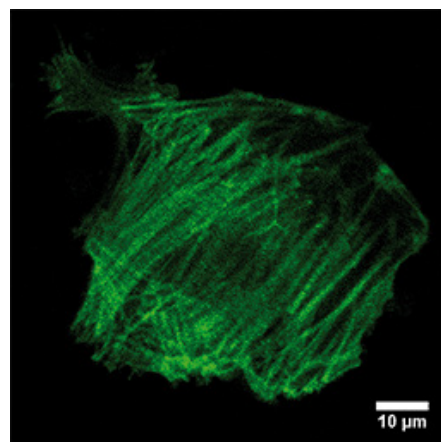

Watch the Movies

Watch these movies and find more live cell imaging examples [on our website](#).

Live Cell Imaging of Actin Dynamics in a Chemotactic Gradient

F-actin networks play an important role during cell migration, which can be investigated in detail using chemotactic gradients. Primary dendritic cells were isolated from mice and transfected with the [LifeAct Plasmid](#).

For the [chemotaxis assay](#), cells were seeded on the [μ-Slide Chemotaxis](#) and a chemotactic gradient (CCL19) was applied. One day after the transfection, F-actin dynamics in the migrating cells were visualized using live cell imaging.

Live cell imaging of actin dynamics in a LifeAct-expressing primary dendritic mouse cell after the application of a chemotactic gradient.

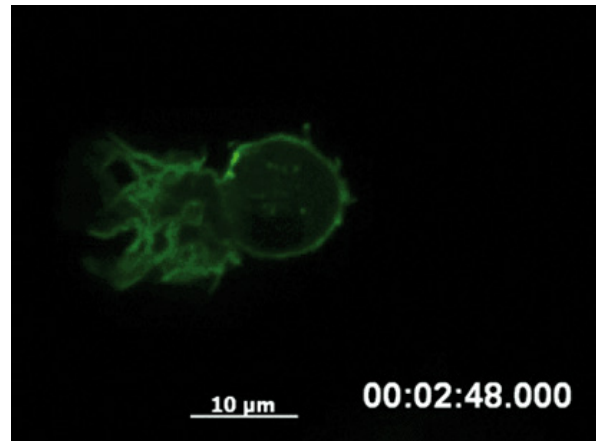

Imaging of Actin Dynamics Under Flow

Several cell types in biofluidic vessels, such as endothelial cells and immune cells, are constantly exposed to shear stress *in vivo*. This mechanical stimulus has a great impact on the physiological behavior and adhesion properties of cells, and should be taken into account when performing respective studies.

By combining the ibidi channel slides, [μ-Slide I Luer](#) or [μ-Slide VI^{0.4}](#), and the [ibidi Pump System](#) with ibidi's [LifeAct technology](#), the F-actin cytoskeleton can be visualized in living cells under shear stress conditions. The [ibidi Pump System](#) is ideal for the long-term application of physiological shear stress to a cell layer and enables the adjustment of different flow rates. The system is fully compatible with live cell imaging and high-resolution fluorescence microscopy. Optionally, the fixation and immunofluorescence staining of the cells can be directly performed in the [μ-Slide I Luer](#).

Experimental Setup:

- Device: [ibidi Pump System](#)
- Slide: [μ-Slide I^{0.4} Luer](#) (ibiTreat)
- Cells: LifeAct-expressing endothelial cells (HUVEC, P1), transduced with the LifeAct Adenoviral Vector [rAV-LifeAct-TagGFP2](#)
- Shear stress parameters: 20 dyn/cm²

Live cell imaging under flow: actin cytoskeleton visualization in HUVEC after transduction with the LifeAct Adenoviral Vector rAV-LifeAct-TagGFP2 and cultivation under 20 dyn/cm²

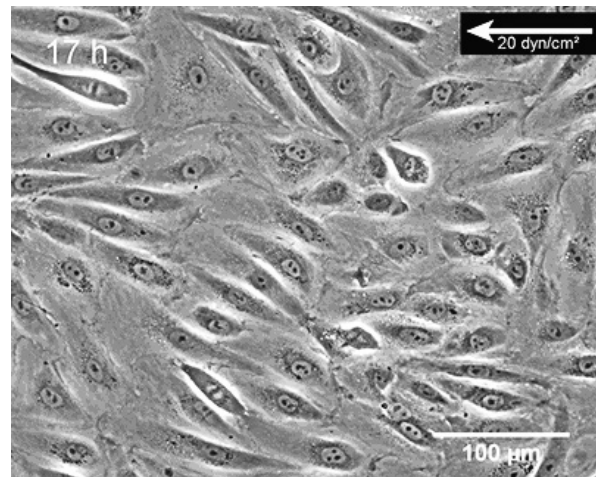
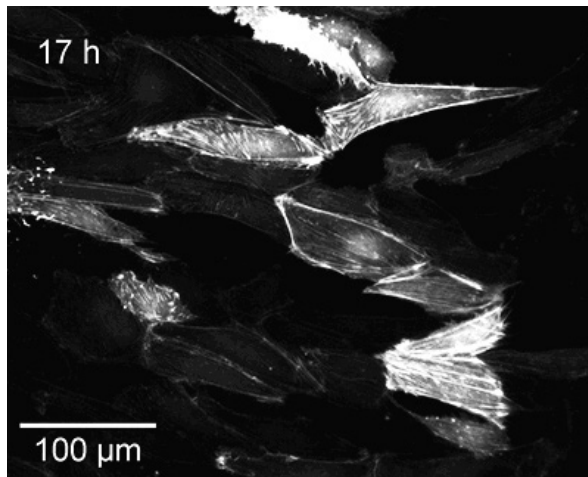

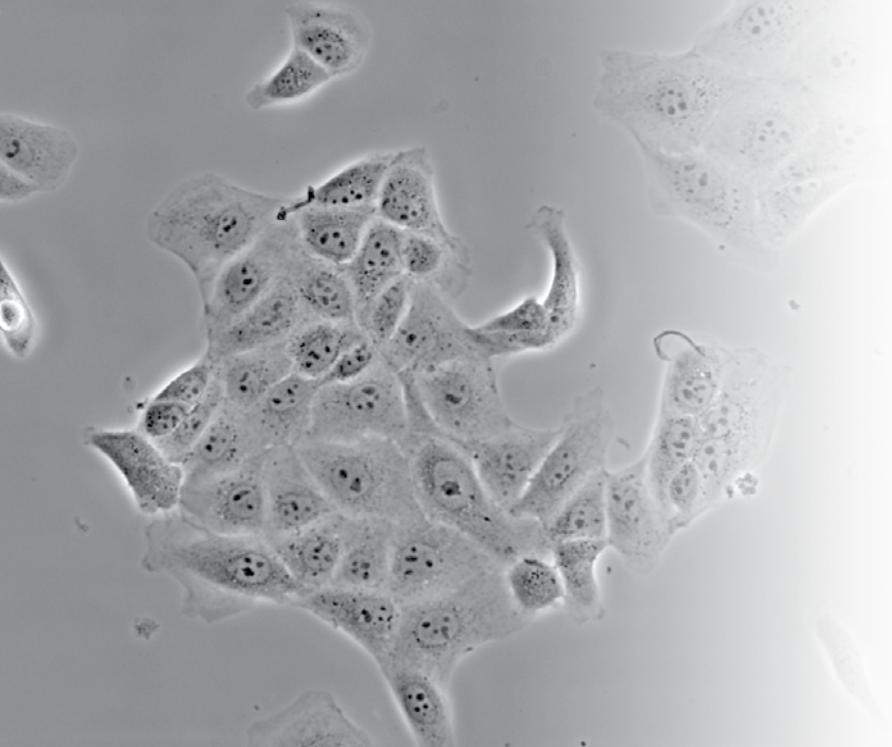

Manufacturer

ibidi GmbH
Lochhamer Schlag 11
82166 Gräfelfing
Germany

Toll free within Germany:
Phone: 0800/00 11 11 28
Fax: 0800/00 11 11 29

International calls:
Phone: +49 89/520 46 17-0
Fax: +49 89/520 46 17-59

E-Mail: info@ibidi.com
ibidi.com

North American Headquarters

ibidi USA, Inc.
2920 Marketplace Drive
Fitchburg, WI 53719
USA

Toll free within the US:
Phone: +1 844 276 6363

International calls:
Phone: +1 608 441 8181
Fax: +1 608 441 8383

E-Mail: ibidiusa@ibidi.com
ibidi.com

All ibidi products are for research use only! Errors and omissions excepted.

© ibidi GmbH
FL_AG_038, V 1.0 2019/06

For free samples, application notes, and handling movies, please visit us at:

 **ibidi.com**