

# *PRODUCT OVERVIEW*





# PRODUCT OVERVIEW



GRABNER INSTRUMENTS, a member of the AMETEK Oil & Gas Business Unit, is considered one of the world's leading developers and manufacturers of automatic petroleum testing equipment. Founded in 1987 by Dr. Werner Grabner, the company became part of AMETEK in 2003.

GRABNER INSTRUMENTS' success is based on the development of portable, rugged and easy-to-operate analyzers, that help companies test their fuels and solvents in an accurate, fast, safe and economic way.

Besides the classical downstream petroleum sector our instruments are dominating the field of automotive, aviation, marine and racing fuel testing. They are highly recommended for testing flavors, fragrances, food, petrochemicals and biofuels, plastics, adhesives, paints and varnishes. They are the preferred analyzers for research and development, for governmental agencies and for accredited laboratories. And they are being used in the mining, the chemical and the pharmaceutical industry, as well as in waste plants, incinerating plants and power plants, both in labs and in the field.



AMETEK Oil & Gas is a group of companies specializing in meeting the unique measurement and instrumentation needs of the Oil & Gas Industry.

Our portfolio of products offers solutions for the upstream, midstream and downstream segments of the industry. From instruments and equipment for production to petroleum product testing equipment for terminals and consumers, AMETEK Oil & Gas

offers many technologies, systems and solutions that are unique to our member companies.

We strive to provide the highest level of support and service our customers expect from a world-class manufacturer. Our offices and sales channels span the globe to offer our customers knowledgeable and responsive support through regional or local presence. AMETEK Oil & Gas is a division of AMETEK, Inc.



AMETEK is a global leader in electronic instruments and electromechanical devices with colleagues at numerous manufacturing, sales and service locations in the U.S. and in many other countries around the world.

AMETEK consists of two operating groups: Electronic Instruments and Electromechanical.

Electronic Instruments is a leader in advanced instruments for the process, aerospace, power and industrial markets.

Electromechanical is a differentiated supplier of electrical interconnects, precision motion control solutions, specialty metals, thermal management systems, and floor care and specialty motors.

# PRODUCT ADVANTAGES



## HIGHEST PRECISION.

Grabner Instruments analyzers are known to be the most precise. They are optimizing customer products and profits.



## FAST MEASUREMENTS.

Measurements on a Grabner analyzer run faster. They are streamlining customers processes.



## SMALL. LIGHT. PORTABLE.

The instruments are small and portable. Bring them to the source of sampling or to other laboratories.



## HIGHEST SAFETY.

Our methods are the safest. For our customers and our environment.



## AUTOMATIC MEASUREMENTS.

Automation reduces operator bias. For assured testing in the laboratory.



## MINIMUM SAMPLE.

Our analyzers help to reduce waste. Because only a minimum sample is required.



## ROBUST.

We use only robust material of superior quality. To make our instruments reliable working horses for daily testing.

# VAPOR PRESSURE

**MINIVAP** testers are worldwide market leader for **vapor pressure testing** in oil and pipeline companies and independent test laboratories, with an installed base of more than 5000 analyzers. Engineered for **superior performance and unmatched precision**, Gasoline, Aviation Fuels, Crude Oil, LPG, Solvents and Chemicals are tested according to all major industry standards. MINIVAP analyzers have proven their performance in ASTM interlaboratory studies and are reference analyzers for US EPA and CARB.



## Automotive Industry

The vapor pressure of Gasoline and LPG is measured to check conformance of motor fuels to summer and winter grade specifications and to prevent vapor lock. The vapor pressure at different temperatures is used to determine requirements for the development of motors, carburetors, fuel injection systems, gasoline pumps, tanks and fuels systems. It can be used to analyze, if newly developed motors are able to handle the requirements of future fuels at high temperatures.



## Aviation Industry

The vapor pressure of AVGAS (ASTM D910 or Def Stan 91-90) is determined according to ASTM D5191 or D6378. It is typically lower than the vapor pressure of automotive fuels, to prevent vapor lock at reduced atmospheric pressure in higher altitude.



## Biofuels

Ethanol blends develop nonlinear vapor pressure behaviour, once a critical amount of Ethanol is blended into gasoline. The vapor pressure and the  $T_{(V/L)}$  of Ethanol blends is measured to confirm compliance with automotive fuel specifications. The analysis of Ethanol blends plays an important role for the development of new motors, like flex-fuel motor systems.



## Flavors, Fragrances, Food, Chemicals

To ensure compliance with hazardous goods and transport regulations or for completing Safety Data Sheets, the absolute vapor pressure of chemicals has to be tested. The Triple Expansion Method is a static method, designed to measure the absolute vapor pressure of liquids. It can be used for measuring single- or multi-compound solvents.



## Laboratory Inspection, Environmental

In a laboratory, the vapor pressure of Gasoline, Crude Oil, LPG and solvents is tested to certify product compliance with volatility and air pollution regulations. The versatile MINIVAP testers perform according to all major industry standards, such as ASTM D6378, D6377, D6897, D5188, D5191, EN 13016, IP 394 and IP 409. Measurements can be done at various temperatures and Vapor/Liquid ratios.



## Military

Gasoline and Jet Fuel vapor pressure is tested directly in the field. Our instruments are used for monitoring fuel quality in military storage tanks.



## Petroleum

The petroleum industry analyzes the vapor pressure of Gasoline, Crude Oil, LPG and NGL to optimize product blending while ensuring that governmental regulations are being met. Applications may also include studies on vapor lock or the determination of the Bubble Point and the TVP, to protect facilities for fuel storage and transportation.



## Pharmaceutical

Vapor pressure measurements help to evaluate the evaporation behaviour of compounds and agents, to determine storage and transportation requirements, to ensure pollution control and to define product specifications according to the latest ASTM, EN and IP standards. For research and development the vapor pressure versus temperature behavior (ASTM D5188) can be tested with the MINIVAP.



## Transportation and Storage

Gasoline, Crude Oil and LPG vapor pressure is tested to allow proper blending and to determine the product quality prior to transportation. Vapor Pressure is also critical to ensure safe tank storage and to minimize outgassing. Determining the TVP or Bubble Point is extremely important to prevent pumping cavitation in pipelines. Testing the vapor pressure at a Vapor/Liquid ratio of 0.02/1 allows a perfect simulation of conditions in an oil-tanker.

# VAPOR PRESSURE INSTRUMENTS

Highest Precision  
Quick Turnaround  
No Product Give-Away  
No Operator Bias  
Minimum Waste

## Samples





-  Gasoline, Gasohol
-  Crude Oil
-  Jet Fuels
-  LPG
-  Solvents
-  Chemicals

- VP Measurement According to All Relevant Standards for Gasoline, Crude and LPG
- Highest Precision and Accuracy
- Best-in-class Sampling Pro™ Valve Design
- Widest Pressure Range: 0 - 2000 kPa
- Certified for Robustness and Durability
- Complete Calibration History and Backup
- Customizable User Templates
- 10" Color Touch Screen
- Total Connectivity through Cockpit™ Software

## MINIVAP VP VISION



## Samples



-  Gasoline, Gasohol
-  Jet Fuels
-  Solvents
-  Chemicals

- Unmatched Precision and Accuracy for Low Volatility VP Measurements
- Modern Replacement of ASTM D2879 Isotenoscope Method
- Static Triple Expansion Method
- Pressure range from 0 - 150 kPa
- Only 1 mL Sample (excl. rinsing)
- 5 Minutes Measuring Time
- 10" Color Touch Screen
- Total Connectivity through Cockpit™ Software

## MINIVAP VPL VISION



## Samples





-  Gasoline, Gasohol
-  Crude Oil
-  Jet Fuels
-  LPG
-  Solvents
-  Chemicals

- All Standard VP Methods included
- Pressure range from 0-1000 kPa
- Excellent Precision and Accuracy
- Only 1 mL Sample (excl. rinsing)
- 5 Minutes Measuring Time
- DVPE and T (V/L = 20) in One Run
- Sampling Pro™ Valve Design
- Integrated Shaker for Rapid Equilibrium
- Optional Crude Oil or LPG Package
- Maintenance Free Measuring Cell

## MINIVAP VPXPERT



## Samples

-  Gasoline, Gasohol
-  Crude Oil
-  Jet Fuels
-  LPG

- ASTM Compliant, Direct VP Measurement
- RVPE, DVPE, TVP,  $T_{(V/L)} = 20$
- Unmatched Accuracy in Process
- Up to 2 Sample Streams
- 7 Minutes Cycle Time
- Automatic Calibration
- Variable V/L Ratio
- Fast & Easy Maintenance
- Amortization Within Weeks

## MINIVAP ON-LINE



# VAPOR PRESSURE SPECIFICATIONS

## MINIVAP VISION



<b>Test Methods</b>	ASTM D5188, 5191, 6377, 6378, 6897; EN 13016; IP 394, 409, 481; GOST 52340, JIS K2258-2, SHT 0769; ASTM D4953 and D323 equivalent
<b>Temperature Range</b>	Measured: 0 to 120°C (32 to 248°F), user programmable Extrapolated: -100 to 300°C (-148 to 572°F)
<b>Temperature Stability</b>	±0.01°C (±0.018°F)
<b>Pressure Range</b>	0 to 2000 kPa (0 to 290 psi)
<b>Vapor/Liquid Ratio</b>	0.02/1 to 100/1, depending on method
<b>Sample Volume</b>	1 mL (2.2 mL per rinsing cycle)
<b>Precision</b>	Repeatability ≤ 0.2 kPa (pure substance @ 37.8°C) Reproducibility ≤ 0.5 kPa (pure substance @ 37.8°C)

## MINIVAP VPL VISION



<b>Test Methods</b>	ASTM D5191, D5188, D6378; EN 13016-1+2, IP 394, 409, JIS K2258-2, SHT 0769
<b>Temperature Range</b>	Measured: 0 to 120°C (32 to 248°F), user programmable Extrapolated: -100 to 300°C (-148 to 572°F)
<b>Temperature Stability</b>	±0.01°C (±0.018°F)
<b>Pressure Range</b>	0 to 150 kPa (0 to 21.8 psi)
<b>Vapor/Liquid Ratio</b>	0.02/1 to 100/1, depending on method
<b>Sample Volume</b>	1 mL (2.2 mL per rinsing cycle)
<b>Precision</b>	Repeatability ≤ 0.2 kPa (pure substance @ 37.8°C) Reproducibility ≤ 0.5 kPa (pure substance @ 37.8°C)

## MINIVAP VPXPERT



<b>Test Methods</b>	ASTM D5188, 5191, 6377, 6378, 6897; EN 13016; IP 394, 409, 481; GOST 52340, JIS K2258-2, SHT 0769; ASTM D4953 and D323 equivalent
<b>Temperature Range</b>	0 - 120°C (32 - 248°F)
<b>Temperature Stability</b>	±0.01°C (±0.02°F)
<b>Pressure Range</b>	0 - 1000 kPa (0 - 145 psi)
<b>Vapor/Liquid Ratio</b>	0.02/1 to 100/1, adjustable per selected method
<b>Sample Volume</b>	1 mL (2.2 mL per rinsing)
<b>Precision</b>	Repeatability = 0.3 kPa, Reproducibility = 0.7 kPa

## MINIVAP ON-LINE



<b>Test Methods</b>	ASTM D5188, 5191, 6377, 6378, 6897; EN 13016; IP 394, 409, 481; ASTM D323 and D4953 equivalent
<b>Temperature Range</b>	20 - 60°C (68 - 140°F)
<b>Temperature Stability</b>	±0.1°C (±0.2°F)
<b>Pressure Range</b>	Gasoline/Crude Oil: 0 - 1000 kPa (0 - 145 psi) LPG: 0 - 2000 kPa (0 - 290 psi)
<b>Vapor/Liquid Ratio</b>	0.02/1 to 20/1
<b>Sample Volume</b>	1 mL (10 mL incl. rinsing)
<b>Precision</b>	Repeatability = 0.3 kPa, Reproducibility = 0.7 kPa
<b>Power Supply</b>	100/120/230/240 V AC, 50/60 Hz, 110W
<b>WxHxD; Weight</b>	580 x 1060 x 260 mm; 50 kg



# VAPOR PRESSURE INSTRUMENTS

Highest Precision  
Quick Turnaround  
No Product Give-Away  
No Operator Bias  
Minimum Waste

## Samples

 Crude Oil

 LPG

### VPXPERT CRUDE OIL PACKAGE

- 250 mL Floating Piston Cylinder
- Fixed Pressure Regulator
- Crude Oil Standard Inlet
- Tubings for 2000 and 7000 kPa Filling Pressure
- Tubing for Non-Pressurized Filling
- Filters for Particle Filtration

### CRUDE OIL PACKAGE



## Samples

 Gasoline, Gasohol

 Jet Fuels

### VPXPERT AUTOSAMPLER FOR RAPID AND CONTINUOUS VAPOR PRESSURE TESTS

- Plug and Play
- Sampling Pro™ Valve Design
- Water Cooling
- Corrosion Protection
- 12 position sampler for highest throughput

### RUN12 AUTOSAMPLER



## Samples

 High Pressure Pipeline Samples

### VP VISION PIPELINE PACKAGE

- For Pressures >2000 kPa
- Tubing for 7000 kPa Filling
- 250 mL Floating Piston Cylinder
- Fixed Pressure Regulator
- Crude Oil Standard Inlet

### HIGH PRESSURE PIPELINE PACKAGE



## VAPOR PRESSURE SPECIFICATIONS

### CRUDE OIL PACKAGE (VPXPRT)



<b>Test Method</b>	ASTM 6377
<b>Floating Piston Cylinder</b>	Max. 7000 kPa (1000 psi), 250 mL sample volume, incl. stirrer, manometer and rupture disk
<b>Filling Tube (Stainless Steel)</b>	Pressurized filling up to max. 7000 kPa (1000 psi)
<b>Filling Tube (PTFE)</b>	Pressurized filling up to max. 2000 kPa (290 psi)
<b>Calibration Tube (PTFE)</b>	Filling at atmospheric pressure
<b>Filters for FPC 250</b>	5 spare filters to prevent clogging / wax contamination
<b>Pressure Regulator</b>	Reduces inlet pressure
<b>Coupling</b>	Special coupling for crude oil filling tubes
<b>Optional</b>	Additional manometer for back pressure measurement, with built-in relief valve

### RUN12 AUTOSAMPLER (VPXPRT)



<b>Sampling</b>	12 separate ports, equipped with filters
<b>Corrosion resistant construction</b>	Wetted parts are made of stainless steel, brass, aluminum or PTFE
<b>Viscosity range</b>	0 - 250 mPas at filling temperature
<b>Filling</b>	automatic via tubes or from glass syringes
<b>Interfaces</b>	I <sup>2</sup> C, USB
<b>Power Supply</b>	12V, 2.5 A

### PIPELINE PACKAGE (VP VISION)



<b>Test Method</b>	ASTM 6377, D6897
<b>Floating Piston Cylinder</b>	Max. 7000 kPa (1000 psi), 250 mL sample volume, incl. stirrer, manometer and rupture disk
<b>Filling Tube (Stainless Steel)</b>	Pressurized filling up to max. 7000 kPa (1000 psi)
<b>Pressure Regulator</b>	Reduces inlet pressure to <2000 kPa
<b>Coupling</b>	Special coupling for crude oil filling tubes
<b>Optional</b>	Additional manometer for back pressure measurement, with built-in relief valve

# FLASHPOINT

**MINIFLASH** is a uniquely designed flashpoint tester series that uses the continuously closed cup method to determine the flash point of petroleum products, liquids and solids with only 1 mL of sample. The Grabner method is the **safest and most economic** flashpoint method that also offers the highest repeatability and reproducibility, an excellent and ASTM proven correlation to the D93 Pensky-Martens method and delivers results equivalent to other closed cup standards.



## *Automotive and Aviation Industry*

MINIFLASH testers are used for safe and fast flashpoint testing of Diesel and Aviation Turbine fuels, for the assessment of fuel contamination, and for the development and quality control of motor oils. The analyzers measure according to ASTM D6450 and D7094, results are rated equivalent to the D93A Pensky Martens method and correlate well to Abel, TAG and small scale methods.

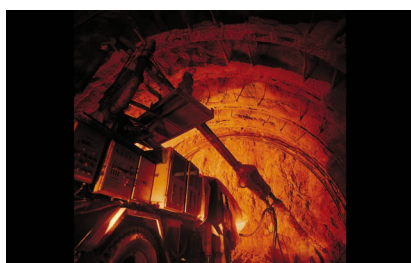

## *Construction and Mining*

Flashpoint measurements help to monitor the quality of Diesel and lubricating oils. The MINIFLASH also includes a fuel dilution feature, which is used to verify fuel contamination into oil for heavy duty machinery. A portable flashpoint tester is a perfect testing tool for remote areas, that offer only a minimum of infrastructure. Companies like CATERPILLAR are using the MINIFLASH.



## *Flavors and Fragrances, Chemicals*

MINIFLASH is the world wide market leader in the Flavors & Fragrances industry. Only 1-2 mL sample is required! Further applications include testing of solvents, paints, adhesives and other chemicals. The determination of the flashpoint is required to document compliance with transport regulations, for defining product specifications and to complete material safety data sheets.



## *Energy*

In conventional and nuclear power plants, flashpoint tests are being used for analysing the quality of hydraulic and transformer oils.



## *Laboratory Inspection*

Our instruments are used for accurate flashpoint determination of petrochemicals, lube and used oils, solvents, paints and chemicals, according to the modern flashpoint standards ASTM D6450 and D7094, in excellent correlation to ASTM D93, D56, ISO 2719, ISO 3679 and ISO 3680 standards. D7094 is listed as alternative method in ASTM Diesel Fuel and Biodiesel Blend specifications. The MINIFLASH is approved by US D.O.T. for analysing class 3 flammable liquids for transportation in commerce.



## *Lubricants, Greases*

The flashpoint of lubricants has to be tested to determine product specification and to verify compliance with transport regulations. For laboratories with a high throughput, that require testing of more than 20,000 samples per year, Grabner Instruments designed the 8-position sampler MINIFLASH FLAH.



## *Military and Marine Fuels*

Military vessels navigating the oceans around the globe use the portable MINIFLASH flashpoint tester to check the quality of their fuels and oils. The fuel dilution measurement method in the MINIFLASH was developed to test the level of fuel contamination in oil onboard Navy ships. This method can also be used for leak detection in lubricated bearings.



## *Petroleum and Biofuels*

Strict safety regulations in refinery laboratories speak against using open flames near highly flammable liquids. The MINIFLASH is the safest flashpoint tester available, very user friendly, efficient and strong enough to last even in an offshore environment. It is used for testing Petrochemicals, Diesel, Lube and Used Oils, Biofuels, Blends and for analyzing oily waste water in upstream exploration. ASTM D7094 is listed as alternative method in ASTM Diesel Fuel and Biodiesel Blend specifications and ASTM D6450 is listed as alternative method in ASTM D6751 B100 specifications.









## *Waste*

For safe thermal disposal or for storage of flammable liquids, the flashpoint of liquid and solid waste, used oil, oily waste water and pharmaceutical waste water has to be analyzed. The versatile MINIFLASH is highly recommended by disposal plants and approved by RCRA.

# FLASHPOINT INSTRUMENTS

Saves Test Costs  
Reduces Hazardous Waste  
Eliminates Safety Risks  
Increases Turnaround  
Reduces Cleaning

## Samples







-  Petroleum, Biofuels
-  Chemicals
-  Flavors & Fragrances
-  Lube & Used Oils
-  Paints & Varnishes
-  Solids, Bitumen

- The Most Economic Flashpoint Test Method
- Includes all MINIFLASH Advantages plus
  - Equilibrium Flashpoint Methods
  - Automatic Ignition Cleaning
  - Full Remote Operation via Web Browser
  - Remote Diagnostics and Support
  - Direct USB, LAN, LIMS and PC Connection
  - Intuitive Menu Navigation on 8.4" Touch Screen
  - Microsoft® Windows® Software
  - Extended Temperature Range
  - Front USB Port for Convenient Data Transfer

## MINIFLASH FLP/H TOUCH



## Samples





-  Petroleum, Biofuels
-  Chemicals
-  Flavors & Fragrances
-  Lube & Used Oils
-  Paints & Varnishes
-  Solids, Bitumen

- Advanced Standards ASTM D6450 and D7094
- No Bias to ASTM D93A
- Best Repeatability and Reproducibility
- Highest Safety: No Open Flame
- Smallest Sample Size: 1 or 2 mL
- Fastest Turnaround: Peltier Cooling
- Portable, Easy to Clean and Durable Design
- Approved by US DOT, RCRA, NATO, US Navy
- NSN 6630-25-145-3256 (FLPH)

## MINIFLASH FLP/H/L



## Samples







-  Diesel
-  Jet Fuels
-  Lube & Used Oils
-  Marine Fuels

- ASTM D6450 and D7094
- US Marine Aviation Fuel Acceptance Protocols
- US Navy-Specs Protocols (NAVIFLASH)
- Oil/Diesel Contamination Detection
- F-76 Fuel Dilution of 9250 Oil
- JP-5 Fuel Dilution of 9250 Oil
- JP-5, JP-8, Jet A1, Diesel and DF-2 Specs
- Ideal for Shipboard Testing
- NSN 6625-01-472-6783 (NAVIFLASH)
- NSN 6630-01-534-1774 (MARFLASH)

## MARFLASH/ NAVIFLASH



## Samples

-  Petroleum, Biofuels
-  Chemicals
-  Flavors & Fragrances
-  Lube & Used Oils
-  Paints & Varnishes
-  Solids, Bitumen

- Fully Integrated 8 Position Sampler
- Fast and Unattended Operation
- Up to 80 Samples per Day
- Fast Cleaning
- Fast Thermoelectric Cooling
- Easy Programming Dialogue
- NSN 6630-25-146-0895 (FLAH)

## MINIFLASH FLA/H



# FLASHPOINT SPECIFICATIONS

## MINIFLASH FLP/H TOUCH



<b>Test Methods</b>	ASTM D6450 (SHT0768), D7094 excellent correlation to ASTM D93, D56, D3828, ISO 2719, 3679, 3680
<b>Fuel Specifications</b>	D7094: ASTM D396, D975, D2880, D3699 (Diesel); D7467 (B6-B20) D6450: ASTM D6751 (B100)
<b>Temperature Range</b>	FLP TOUCH: 0 - 200°C (32 - 392°F) FLPH TOUCH: 0 - 400°C (32 - 752°F); tap water cooling
<b>Temperature Stability</b>	±0.1°C (±0.2°F)
<b>Sample Volume</b>	1 mL (ASTM D6450) 2 mL (ASTM D7094)
<b>Sample Throughput</b>	up to 12 samples/h

## MINIFLASH FLP/H/L



<b>Test Methods</b>	ASTM D6450 (SHT0768), D7094; excellent correlation to ASTM D93, D56, ISO 2719
<b>Fuel Specifications</b>	D7094: ASTM D396, D975, D2880, D3699 (Diesel); D7467 (B6-B20) D6450: ASTM D6751 (B100)
<b>Temperature Range</b>	FLP: 0 to 200°C (32 to 392°F) FLPH: 10 to 400°C (50 to 752°F) FLPL: -25 to 100°C (-13 to 212°F)
<b>Temperature Stability</b>	±0.1°C (±0.2°F)
<b>Sample Volume</b>	1 mL (ASTM D6450) 2 mL (ASTM D7094)
<b>Sample Throughput</b>	up to 12 samples/h

## MARFLASH / NAVIFLASH



<b>Test Methods</b>	ASTM D6450 (SHT0768), D7094
<b>Fuel Specifications</b>	D7094: ASTM D396, D975, D2880, D3699 (Diesel); D7467 (B6-B20) D6450: ASTM D6751 (B100)
<b>Temperature Range</b>	MARFLASH: 0 - 200°C (32 - 392°F) NAVIFLASH: 0 - 400°C (32 - 752°F)
<b>Temperature Stability</b>	±0.1°C (±0.2°F)
<b>Sample Volume</b>	1 mL (ASTM D6450) 2 mL (ASTM D7094)
<b>Sample Throughput</b>	up to 12 samples/h

## MINIFLASH FLA/H



<b>Test Methods</b>	ASTM D6450 (SHT0768), D7094; excellent correlation to ASTM D93, D56, ISO 2719
<b>Fuel Specifications</b>	D7094: ASTM D396, D975, D2880, D3699 (Diesel); D7467 (B6-B20) D6450: ASTM D6751 (B100)
<b>Temperature Range</b>	FLA: 0 to 200°C (32 to 392°F) FLAH: 10 to 400°C (50 to 752°F)
<b>Temperature Stability</b>	±0.1°C (±0.2°F)
<b>Sample Volume</b>	1 mL (ASTM D6450) 2 mL (ASTM D7094)
<b>Sample Throughput</b>	up to 12 samples/h

# FUEL ANALYSIS

The Grabner fuel analyzers are the ultimate solution for monitoring and optimizing refining and blending, to assess compliance with automotive fuel specifications, to control product contamination and adulteration, for fuel research and for motor development. The product line is headed by the **MINISCAN IR VISION**, the first portable FT-IR multi-fuel analyzer for Gasoline, Jet Fuel, Diesel and Biofuel Blends, which uses full spectrum information and advanced chemometrics for utmost measurement accuracy.



## Automotive Industry

The small sample volume of the Grabner analyzers allows quality checks on small amounts of residual fuels found in the fuel feed line, to clarify warranty issues. The analyzer is used for detecting fuel contamination or adulteration in fuels and to check compliance with Oxygen, Benzene and MMT specifications. Further applications include the analysis of alternative fuels for motor development and the product control in motor racing.



## Aviation Industry

FT-IR measurements are a fast and cost effective way to check the quality of Aviation Turbine Fuels and Aviation Gasoline.



## Biofuels

The MINISCAN IR VISION is designed for the analysis of biofuels content in Gasoline and Diesel. More than 30% Ethanol in Gasoline and 30% FAME in Diesel can be measured according to the international standards EN 14078 and ASTM D7806. Important fuel properties such as Octane and Cetane number, Density and Methanol content are determined within minutes.



## Construction and Mining

Fuel Adulteration and Fuel Contamination is a widespread problem in the construction and in the mining business. The MINISCAN IR VISION Diesel analyzer allows portable contamination and adulteration analysis of Diesel fuels. Key fuel parameters such as Cetane Number, Cetane Index, Cetane Improver, Density, Aromatics, Distillation Properties and Biodiesel content are checked within minutes.

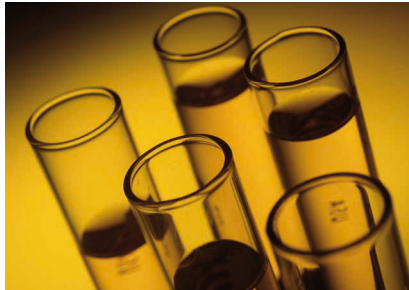

## Laboratory Inspection

The Grabner fuel analyzers allow a comprehensive analysis on fuel quality. Octane Number, Octane Boosters, MMT, Benzene, Oxygenates, Aromatics, Cetane Number, Cetane Improver, Density, Distillation and Vapor Pressure are analyzed within minutes. Compliance with Oxygen, Benzene, Ethanol or FAME limits can be assessed easily, fuel contamination and adulteration is readily identified.



## Military

The portable and robust MINISCAN IR VISION fuel analyzers are an ideal solution for inspection of military stock fuels directly in the field.



## Petroleum

The petroleum industry uses our quick and accurate fuel analyzers to adjust their blending process and to ensure that product quality is maintained. Compared to gas chromatography, FT-IR instruments are a faster, more cost effective and more versatile way to test fuels in refineries, at terminals and in pipelines.



## Transportation and Storage





Adulteration is a widespread problem, especially in developing countries. Fuel contamination on the other hand can be a costly issue for every pipeline operator. Portable fuel analyzers are perfectly suited for monitoring product quality throughout the distribution system. For product comparison, results can be transferred via web to the next sample point.



## FUEL ANALYSIS INSTRUMENTS

Monitor Quality  
Optimize Products  
Detect Contamination  
Save Laboratory Costs  
Save Test Time

### Samples

-  Gasoline, Gasohol
-  Diesel
-  Jet Fuels
-  Biofuel Blends
-  Fuel Adulteration

- Portable FT-IR Fuel Analyzer
- Laser- and Temperature Regulated System
- Superior Resolution
- Advanced Chemometrics
- 10" Full Color Touch Screen
- Full Network and LIMS Integration



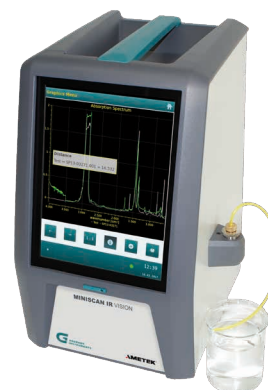

#### 100+ FUEL PARAMETERS ANALYZED

- Oxygenates (ASTM D5845)
- Aromatics, PNA and Benzene (D6277, EN 238)
- Biodiesel (FAME) Content (EN 14078, D7806)
- Octane Booster and Cetane Improver
- Anilines
- Total Aromatics, Olefins, Saturates, Oxygen
- Octane Number: RON, MON, AKI
- Cetane Number, Cetane Index
- Distillation and Vapor Pressure
- Driveability, Vapor Lock and VOC Analysis
- Built-In Temperature Regulated Density
- Jet Fuel: Flash-, Smoke-, Freezing Point, etc.

### MINISCAN IR VISION



### Samples

-  Gasoline, Gasohol
-  Diesel
-  Jet Fuels
-  Crude Oil
-  Biofuel Blends
-  Asphalt
-  Lube & Used Oils

- Fast Inline or Laboratory Measurement
- Real Time Monitoring of Multiple Process Streams
- Automated Results on a Simple Interface
- Validation of Incoming Product
- Improved Product Quality
- Improved Repeatability
- Reduced Expenses
- Minimal Operator Training
- Rapid Return on Investment

### PARAFUEL™ IN-LINE ANALYZER

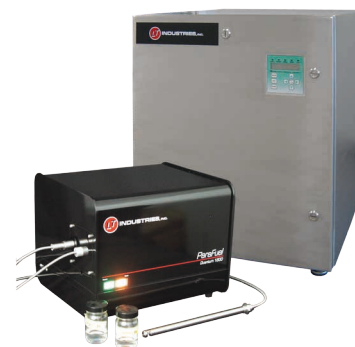

# FUEL ANALYSIS SPECIFICATIONS

## MINISCAN IR VISION

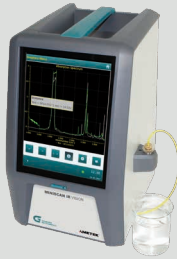

<b>Test Methods</b>	ASTM D5845, D6277, D7777, D7806; EN 238, EN 14078; ISO 15212
<b>Property Prediction based on</b>	ASTM D56/D3828, D86, D323, D445, D613, D1319, D1322, D1840, D2386/D7153, D2699, D2700, D3948, D5191, D6371, D6378, D6379; ISO 3405, 5163, 5164, 5165; EN 13016;
<b>Temperature Stability</b>	±0.1°C (±0.2°F)
<b>Sample Volume</b>	Less than 25 mL
<b>Scanning Time</b>	80s (Multiple Scans)

## PARAFUEL™ IN-LINE ANALYZER



<b>ParaFuel™ Models</b>	ParaFuel™ NIR Process Analyzer + one High Energy Bubble Shedding Probe ParaFuel™ NIR Process Analyzer + Multiplexer + Up to twenty Probes ParaFuel™ NIR Benchtop Analyzer + one Dip Probe
<b>Scan Time</b>	30 seconds (user-adjustable)
<b>Power Supply</b>	100-240 VAC, 50/60 Hz
<b>PROCESS ANALYZER</b>	
<b>Classification</b>	C1D2 Standard, C1D1 Optional
<b>Control System Communication</b>	Modbus RTU Standard (Options: Modbus TCP, 4-20 mA Analog Output Module)
<b>Sample requirements</b>	Up to 150°C and 7000 kPa (1000 psi)
<b>BENCHTOP ANALYZER</b>	
<b>Data Storage</b>	Data automatically logged and stored; Standard TCP/IP connection for integration to LIMS
<b>Dimensions (WxHxD)</b>	305 x 397 x 349 mm (12" x 15" x 13")

# DISTILLATION

**MINIDIS ADXpert** is a portable, true atmospheric and automatic distillation analyzer, designed for laboratory and field use. Fast and highly precise distillation runs make the **MINIDIS ADXpert** a smart alternative to classical **D86 testing**, for **biofuels testing** and for determining the **true boiling point** of liquids. The instrument is specified for use of gasoline, jet fuel and diesel products (groups 0-4), biofuels, solvents, aromatics, organic liquids, chemicals and contaminated or blended samples, using a resolution twice as good as classical apparatus. A distillation run on light products takes just 15 minutes and requires only a 6 mL sample.



## Automotive Industry

Our compact, fast and fully automatic distillation unit is an ideal tool for testing Gasoline, Diesel, Biofuels and Solvents for compliance with specifications and for contamination detection. In the **MINIDIS ADXpert** measurements are performed according to ASTM D7344 and correlate well to ASTM D86 and ISO 3405.



## Aviation Industry

Distillation properties of Aviation Gasolines, Aviation Turbine Fuels and Synthetic Fuels are accurately determined by the **MINIDIS ADXpert**.



## Biofuels

The Grabner analyzer is used to verify distillation properties on high Ethanol blends and B100 Biodiesel. Small and portable, the instrument offers excellent precision and better repeatability on B100 than the classical ASTM D1160 vacuum distillation method and a good repeatability on the T50 of Ethanol blends. Grabner's ASTM D7344 method is listed as alternative method in ASTM D6751 B100 specifications.



## Chemicals and Pharmaceuticals

The **MINIDIS ADXpert** is a unique analyzer that measures both, the True Boiling Point or D86 / ISO 3405 distillation properties, of Chemicals, Solvents and Organic Liquids. A complete analysis on initial boiling point, distillation curve and final boiling point of solvents is delivered within minutes.



## Construction and Mining

Distillation properties are key in determining the quality of Diesel. Distillation yields important information to prevent the use of non-spec fuels and subsequently damage expensive machinery, used for mining and construction work. Because of its automatic heater regulation, the use of the MINIDIS ADXpert is not limited to Diesel: Difficult samples, like raffinates and mining solvents can also be distilled with this instrument.



## Laboratory Inspection

The MINIDIS ADXpert is a versatile distillation unit for testing Gasoline, Naphta, Diesel, Jet Fuels, Biofuels, Chemicals, Solvents, Spirits, Narrow Boiling Products and Organic Liquids. Measurements are performed according to ASTM D7344, the instrument yields either ASTM D86 or True Boiling Point results. Measurements on B100 show excellent repeatability, ASTM D7344 is listed in ASTM D6751 B100 specifications. The portable instrument is ideal for mobile testing at the point of sale.



## Military

A compact, robust and reliable distillation unit is a "must have" for military personnel testing stock fuels directly in the field. The MINIDIS ADXpert guarantees highest safety, neither glassware nor a fire extinguisher is required for this distillation method.



## Petroleum

Our portable analyzer is used to analyze distillation properties of petroleum products in the lab or in the field, to monitor product and pipeline specifications or to simulate fractional distillation. True Boiling Point or ASTM D86 distillation properties are determined automatically, pure Biodiesel is measured with the highest repeatability. Due to the nature of the instrument, the resolution is twice as good as in classical D86 apparatus.

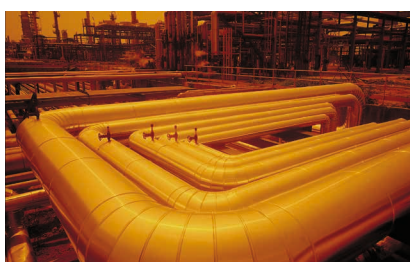







## Transportation and Storage

Manufacturers and distributors of petroleum products have to verify product quality and test compliance with transport regulations by means of distillation. A portable distillation analyzer can easily be moved to terminals, retail outlets, tank farms or pipeline sample points, that are scattered over a wide area.

# DISTILLATION INSTRUMENT

Fast Results  
Small Sample  
Low Running Costs  
Unmatched Versatility  
No Manual Cleaning  
Highest Safety

## Samples

-  Biofuels
-  Chemicals
-  Diesel
-  Fuel Contamination
-  Gasoline, Gasohol
-  Jet Fuels
-  Solvents

## MOST VERSATILE:

- Measurement according to D7344
- Correlates to ASTM D86
- Listed in D6751 B100 Biodiesel Specs
- Tests True Boiling Point
- Tests Unknown Samples
- Tests Refinery Residue
- Detects Dry Point
- Portable for Field Use

## FEATURES:

- True Atmospheric Distillation
- 6 mL Sample Volume
- No Glassware
- 15 min. Distillation on Light Samples
- Automatic Filling & Cleaning
- Automatic Temperature Optimization
- Automatic Final Heat Adjustment
- Best in Class Volume Detection
- Highest Safety
- Low on Consumables

## MINIDIS ADXpert



## MEASURING PRINCIPLE

A disposable sample cup (2) is filled with anti bumping granules to avoid a boil-up effect of the sample. The cup is placed into the cup holder that contains the heating element (1).

Finally the filling tube of the MINIDIS ADXpert is placed into the sample and the RUN button is pressed. The cup is automatically lifted and pressed against the stainless steel distillation column (3). By moving down the piston of the receiving system, a vacuum is generated and monitored for a few seconds to verify the precise positioning and tightness of the sample cup, ensuring no escape of flammable vapors.

A 6 mL sample is transferred from the temperature controlled filling system to the sample cup (2) and heated with the low mass electric heating element (1). The temperature of the released vapor is measured with a NiCr/Ni thermocouple (4). Vapor passes through a condenser tube into a thermostated chamber (5), whose temperature is controlled by a Peltier element. The vapor condenses and the volume of the condensate

is monitored using a combination of a stationary optical meniscus detector (6) and a receiver cell (7), whose volume can be changed by a piston driven by the high precision stepper motor. Once the final boiling point is reached, the sample cup is cooled down to a safe temperature, then removed and weighed using the built-in balance. Residue is determined from the weight difference before and after the distillation.

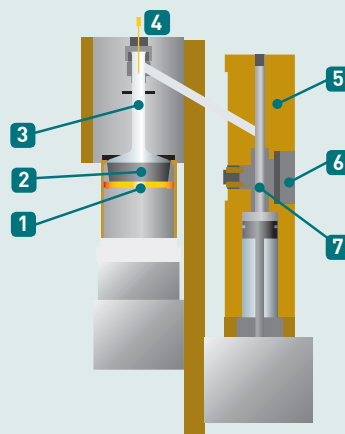

**DISTILLATION**  
**SPECIFICATIONS****MINIDISADXpert**

<b>Test Method</b>	ASTM D7344
<b>Excellent Correlation to</b>	ASTM D86, D1160 (B100), D850, D1078; ISO 3405
<b>Temperature Range</b>	0 to 400°C (32 to 752°F)
<b>Temperature Stability</b>	±0.1°C (±0.2°F)
<b>Sample Volume</b>	6 mL
<b>Measuring Time</b>	15 min. (light samples)

# LUBES, OILS & GREASES

Fast Throughput  
Minimal Waste  
Easy to Operate  
Easy to Clean

**MINITEST FFK** automatically determines the **flow-pressure properties of lubricating grease** at low temperatures down to **-50°C** by means of the **Kesternich test**. The original and time-consuming method is now fully automated and the measuring range is extended far below the original one, resulting in a considerably improved precision. A powerful two stage Peltier element avoids the use of a large and expensive cryostat. The **MINISCAN IR LOG** is a highly versatile and extremely fast FTIR analyzer, designed for on-site condition monitoring of oils and greases.

## Samples



Greases

- Automatic Detection of Flow Pressure
- Fast 2-Stage-Peltier Cooling
- No Cryostat Needed
- Fit for Field Use
- Highest Accuracy
- Easy Handling
- Portable Design

## MINITEST FFK



## Samples



Lube & Used Oils



Greases

- Portable FTIR Analyzer
- Condition Monitoring of Lubes, Oils and Greases
- Designed for Field Use
- Internal battery (4h operation)
- Maintenance free dial-path transmission setup (3 cells)
- Less than 1 mL sample per test
- Easy to set up, easy to use
- Easy to clean
- No rinsing required
- No limit for sample viscosity
- Results within minutes
- Requires no reference measurement w/ chemicals

## MINISCAN IR LOG



## LUBES, OILS & GREASES

# SPECIFICATIONS

### MINITEST FFK



<b>Test Method</b>	DIN 51805 (Kesternich Method)
<b>Temperature Range</b>	-50 to 30°C (-58 to +86°F)
<b>Tap Water Cooling</b>	for below -30°C (-22°F)
<b>Temperature Resolution</b>	±0.1°C (±0.2°F)
<b>Pressure Range</b>	0 to 200 kPa
<b>Pressure Resolution</b>	±0.1 kPa
<b>Precision</b>	better than DIN 51805

### MINISCAN IR LOG



<b>Test Method</b>	ASTM E2412, D664, D2668, D2896, D7412, D7414, D7415, D7418, D7624
<b>Components and Contaminants</b>	Phosphates, Oxidation, Sulfates, Nitration, TAN, TBN, Antioxidants, Antiwear, Extreme Pressure, Antifoam, Water, Esters, Glycol, Antifreeze
<b>Dial Path Setup</b>	50, 100 or 1000 µm
<b>Sample Volume</b>	1 mL
<b>Measurement Time</b>	5 min.







# MOBILE FUEL LAB

Fully Equipped  
Modular Configuration  
Ready to Measure

The **MOBILE FUEL LAB** is the ideal solution for fast and precise fuel quality checks in the field. Equipped with the portable, rugged and fully automated analyzers of Grabner Instruments, a detailed fuel analysis can be performed in 30 minutes by a single person directly on-site.



-  Biofuels
-  Crude Oil
-  Diesel
-  Fuel Contamination
-  Gasoline, Gasohol
-  Jet Fuels
-  LPG
-  Marine Fuels

- Total Quality Control Directly at Site
- Complete Set of Instruments
- Complete Fuel Analysis in 30 min.
- Flexible Instrument Configuration
- Shock Proof Installation
- Instruments Secured for Transport
- Water and Power Supply
- Air Conditioned
- Anti-Skid Flooring
- PC Network
- Optional Sleeper Department

## MOBILE FUEL LAB



## TOTAL QUALITY CONTROL ON THE MOVE

The Mobile Fuel Lab is the best example to highlight our competence: Get results, where you need them. Our instruments are made to sustain the demands on the road: they are small, robust and reliable.

The Mobile Fuel Lab is built and equipped according to your requirements. Select a vehicle and choose the appropriate lab size. Available labs are:

- 3.8 m standard lab
- 4.8 m lab with sleeper compartment
- 7.0 m Super Mobile Lab, including an office
- 13.5 m Articulate Truck, including a living area

All labs are equipped with air-conditioning, ventilation, ducted warm air heating system, a sink with cold and hot water, anti-skid flooring, fire detection

and fire extinguishing systems in accordance with local regulations, a generator, worktops, benches and cupboards. An optional fume-hood is available.

Choose from our large selection of on-board instruments. All instruments are mounted on specially designed shock-absorbers. We are flexible when it comes to integrating your choice of printer, PC or GPS navigation system.



**Our passion is to outperform people's expectations with reliable innovations. We care for a better world and for your success.**



**We provide high-end measurement instruments, systems and services for resource efficient industries.**

Grabner Instruments  
Messtechnik GmbH  
A-1220 Vienna/Austria  
Dr. Otto-Neurath-Gasse 1  
Phone +43/1/282 16 27-0  
Fax +43/1/282 16 27 300  
grabner.sales@ametek.com  
www.grabner-instruments.com

